

## SOT-23 Plastic-Encapsulate Transistors

### FEATURES

- High Collector Current
- Complementary To TKS9013
- Excellent  $h_{FE}$  Linearity

### MARKING: 2T1

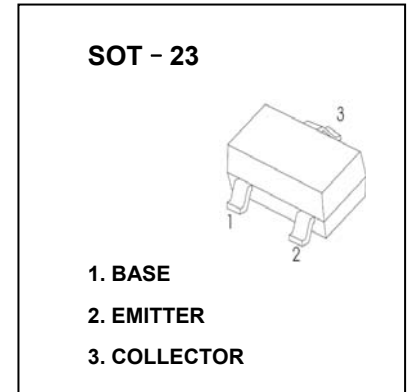

### MAXIMUM RATINGS ( $T_a=25^{\circ}\text{C}$ unless otherwise noted)

Symbol	Parameter	Value	Unit
$V_{CBO}$	Collector-Base Voltage	-40	V
$V_{CEO}$	Collector-Emitter Voltage	-25	V
$V_{EBO}$	Emitter-Base Voltage	-5	V
$I_C$	Collector Current	-500	mA
$P_C$	Collector Power Dissipation	300	mW
$R_{\theta JA}$	Thermal Resistance From Junction To Ambient	416	$^{\circ}\text{C}/\text{W}$
$T_j$	Junction Temperature	150	$^{\circ}\text{C}$
$T_{stg}$	Storage Temperature	-55~+150	$^{\circ}\text{C}$

### ELECTRICAL CHARACTERISTICS ( $T_a=25^{\circ}\text{C}$ unless otherwise specified)

Parameter	Symbol	Test conditions	Min	Typ	Max	Unit
Collector-base breakdown voltage	$V_{(BR)CBO}$	$I_C=-0.1\text{mA}, I_E=0$	-40			V
Collector-emitter breakdown voltage	$V_{(BR)CEO}$	$I_C=-1\text{mA}, I_B=0$	-25			V
Emitter-base breakdown voltage	$V_{(BR)EBO}$	$I_E=-0.1\text{mA}, I_C=0$	-5			V
Collector cut-off current	$I_{CBO}$	$V_{CB}=-40\text{V}, I_E=0$			-0.1	$\mu\text{A}$
Collector cut-off current	$I_{CEO}$	$V_{CE}=-20\text{V}, I_B=0$			-0.1	$\mu\text{A}$
Emitter cut-off current	$I_{EBO}$	$V_{EB}=-5\text{V}, I_C=0$			-0.1	$\mu\text{A}$
DC current gain	$h_{FE}$	$V_{CE}=-1\text{V}, I_C=-50\text{mA}$	200		350	
Collector-emitter saturation voltage	$V_{CE(sat)}$	$I_C=-500\text{mA}, I_B=-50\text{mA}$			-0.6	V
Base-emitter saturation voltage	$V_{BE(sat)}$	$I_C=-500\text{mA}, I_B=-50\text{mA}$			-1.2	V
Transition frequency	$f_T$	$V_{CE}=-6\text{V}, I_C=-20\text{mA}, f=30\text{MHz}$	150			MHz
Collector output capacitance	$C_{ob}$	$V_{CB}=-10\text{V}, I_E=0, f=1\text{MHz}$			5	pF

### CLASSIFICATION OF $h_{FE}$

RANGE	200-350
-------	---------

## Typical Characteristics

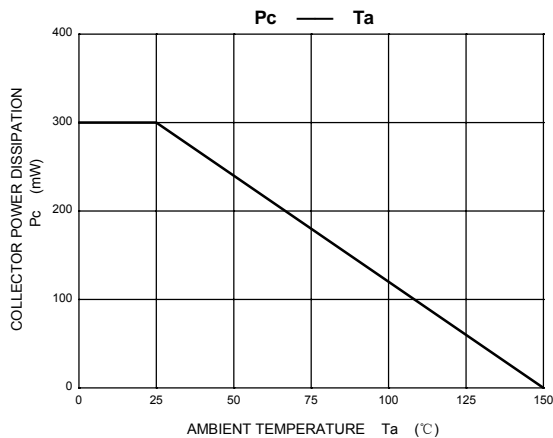
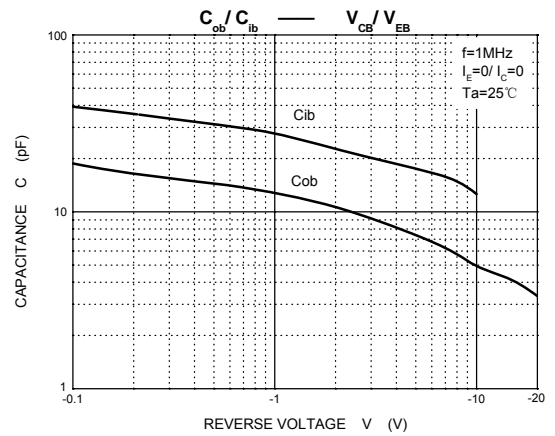
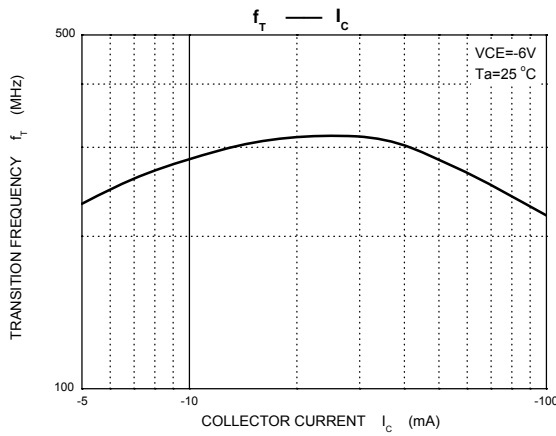
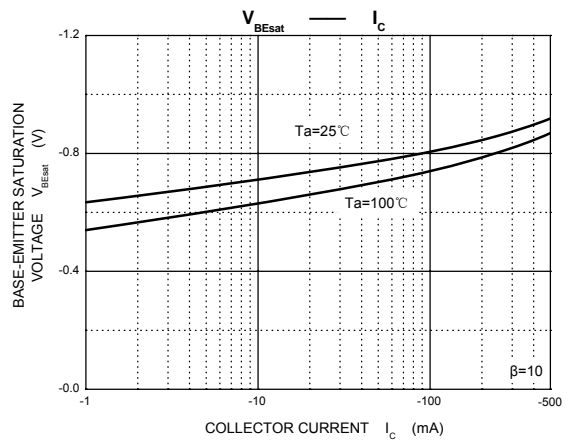
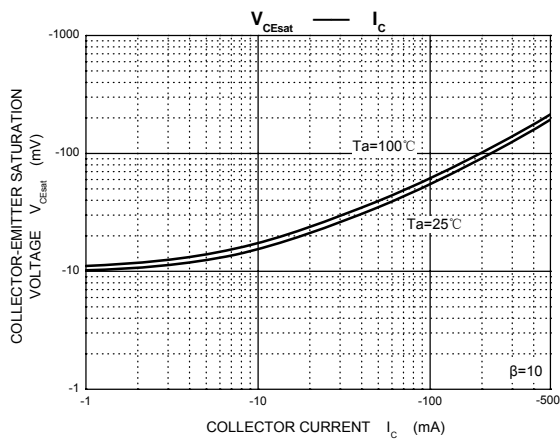
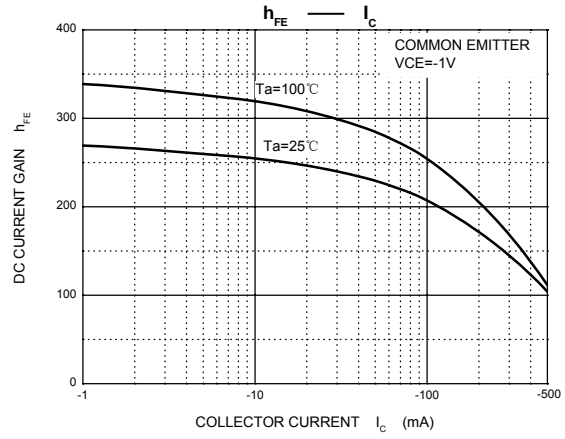
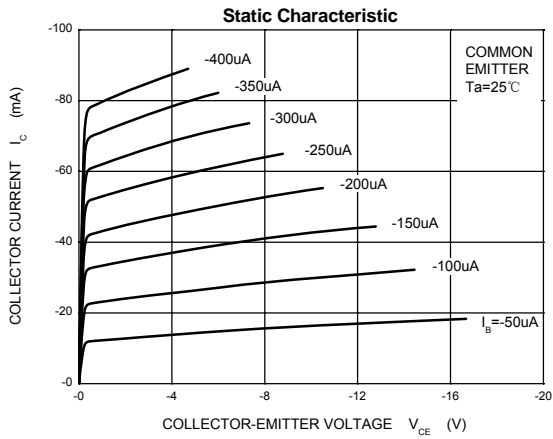

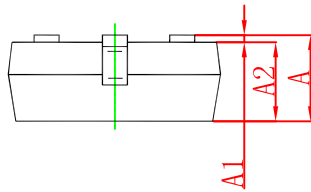
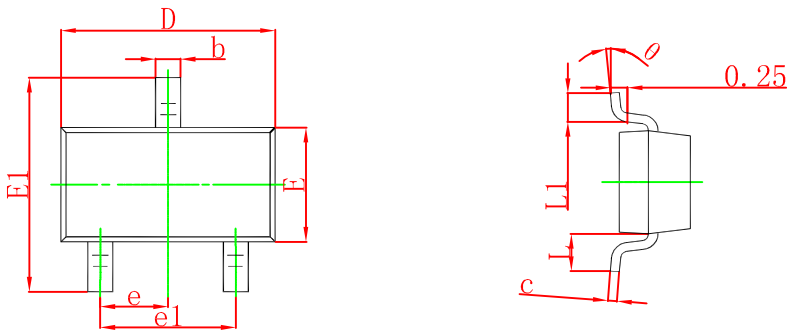

Symbol	Dimensions In Millimeters		Dimensions In Inches	
	Min	Max	Min	Max
A	0.900	1.150	0.035	0.045
A1	0.000	0.100	0.000	0.004
A2	0.900	1.050	0.035	0.041
b	0.300	0.500	0.012	0.020
c	0.080	0.150	0.003	0.006
D	2.800	3.000	0.110	0.118
E	1.200	1.400	0.047	0.055
E1	2.250	2.550	0.089	0.100
e	0.950 TYP		0.037 TYP	
e1	1.800	2.000	0.071	0.079
L	0.550 REF		0.022 REF	
L1	0.300	0.500	0.012	0.020
θ	0°	8°	0°	8°

### SOT-23 Suggested Pad Layout

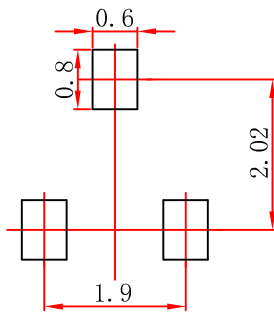

- Note:
1. Controlling dimension: in millimeters.
  2. General tolerance:  $\pm 0.05\text{mm}$ .
  3. The pad layout is for reference purposes only.