

SOT-23 Plastic-Encapsulate Transistors

FEATURES

High voltage transistor

MARKING:2D

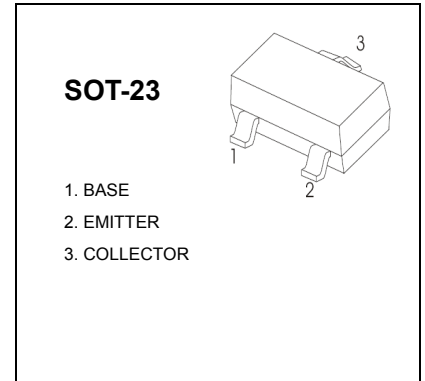

MAXIMUM RATINGS (T_a=25°C unless otherwise noted)

Symbol	Parameter	Value	Unit
V _{CB0}	Collector-Base Voltage	-300	V
V _{CEO}	Collector-Emitter Voltage	-300	V
V _{EBO}	Emitter-Base Voltage	-5	V
I _C	Collector Current -Continuous	-200	mA
I _{CM}	Collector Current -Pulsed	-500	mA
P _C	Collector Power Dissipation	300	mW
T _J	Junction Temperature	150	°C
T _{stg}	Storage Temperature	-55-150	°C
R _{θJA}	Thermal Resistance From Junction To Ambient	417	°C/W

ELECTRICAL CHARACTERISTICS (T_a=25°C unless otherwise specified)

Parameter	Symbol	Test conditions	Min	Max	Unit
Collector-base breakdown voltage	V _{(BR)CBO}	I _C = -100μA, I _E =0	-300		V
Collector-emitter breakdown voltage	V _{(BR)CEO}	I _C = -1mA, I _B =0	-300		V
Emitter-base breakdown voltage	V _{(BR)EBO}	I _E = -100μA, I _C =0	-5		V
Collector cut-off current	I _{CBO}	V _{CB} =-200V, I _E =0		-0.25	μA
Emitter cut-off current	I _{EBO}	V _{EB} = -5V, I _C =0		-0.1	μA
DC current gain	h _{FE(1)}	V _{CE} = -10V, I _C = -1mA	60		
	h _{FE(2)}	V _{CE} = -10V, I _C =-10mA	100	200	
	h _{FE(3)}	V _{CE} = -10V, I _C =-30mA	60		
Collector-emitter saturation voltage	V _{CE(sat)}	I _C =-20mA, I _B = -2mA		-0.2	V
Base-emitter saturation voltage	V _{BE(sat)}	I _C = -20mA, I _B = -2mA		-0.9	V
Transition frequency	f _T	V _{CE} =-20V, I _C = -10mA f=30MHz	50		MHz

Typical Characteristics

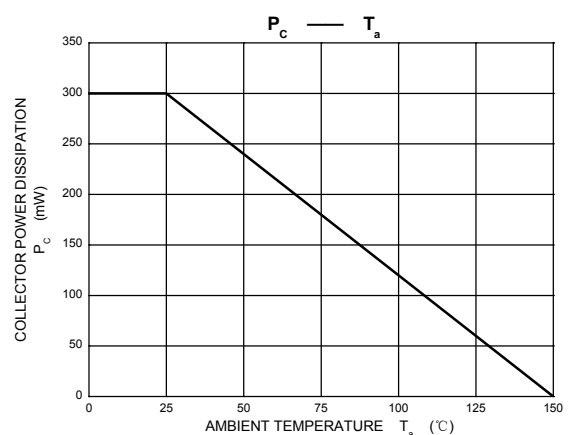
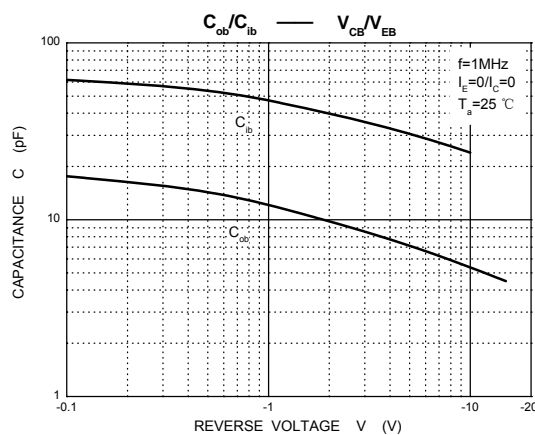
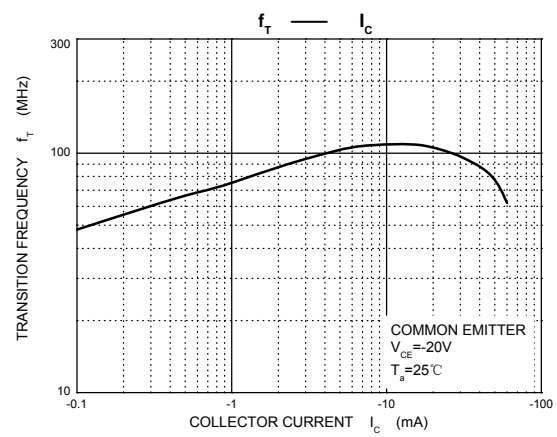
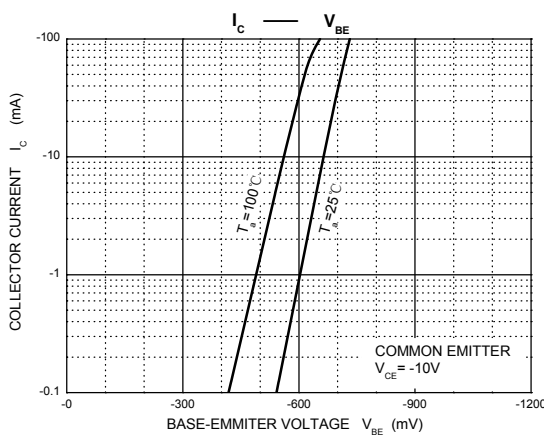
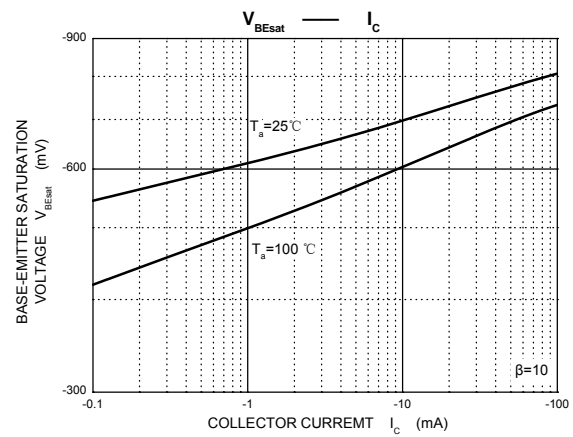
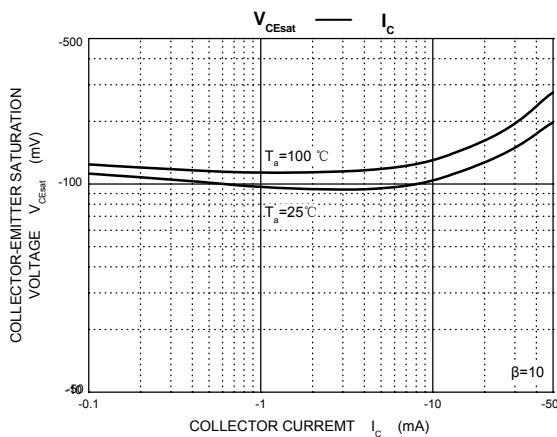
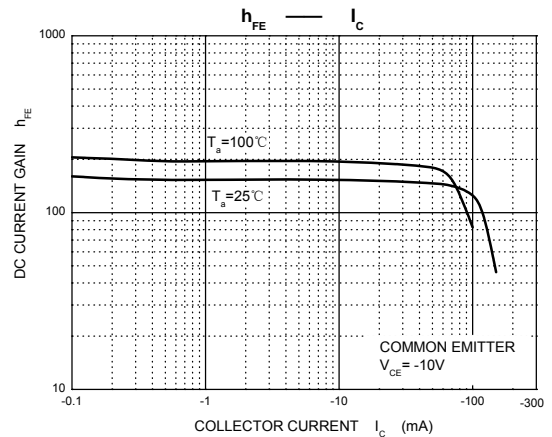
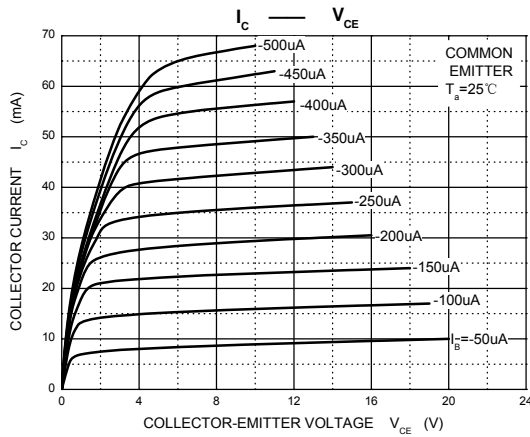

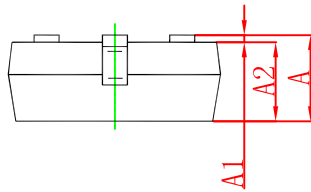
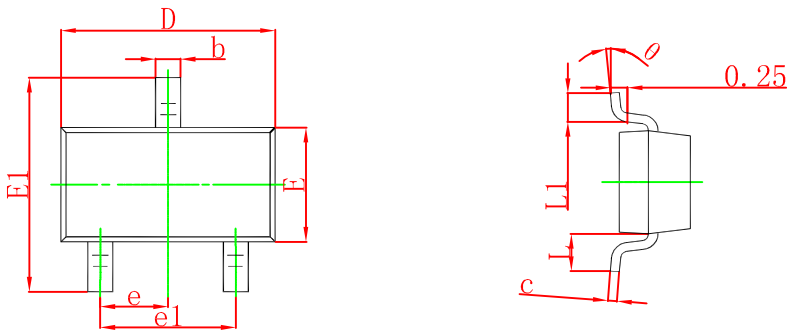

Symbol	Dimensions In Millimeters		Dimensions In Inches	
	Min	Max	Min	Max
A	0.900	1.150	0.035	0.045
A1	0.000	0.100	0.000	0.004
A2	0.900	1.050	0.035	0.041
b	0.300	0.500	0.012	0.020
c	0.080	0.150	0.003	0.006
D	2.800	3.000	0.110	0.118
E	1.200	1.400	0.047	0.055
E1	2.250	2.550	0.089	0.100
e	0.950 TYP		0.037 TYP	
e1	1.800	2.000	0.071	0.079
L	0.550 REF		0.022 REF	
L1	0.300	0.500	0.012	0.020
θ	0°	8°	0°	8°

SOT-23 Suggested Pad Layout

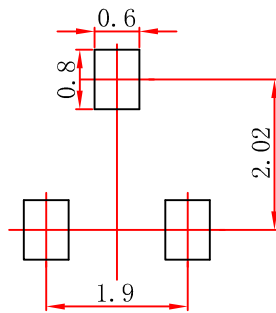

- Note:
1. Controlling dimension: in millimeters.
 2. General tolerance: $\pm 0.05\text{mm}$.
 3. The pad layout is for reference purposes only.