

## SOT-23 Plastic-Encapsulate Transistors

### FEATURES

- Complementary to TKMMBT5551
- Ideal for Medium Power Amplification and Switching

### MARKING: 2L

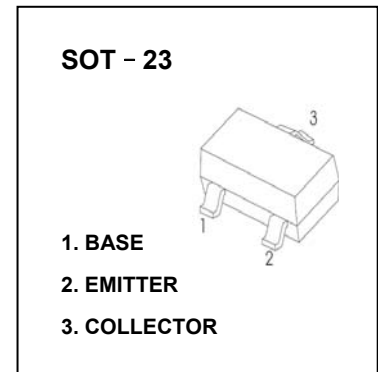

### MAXIMUM RATINGS ( $T_a=25^\circ\text{C}$ unless otherwise noted)

Symbol	Parameter	Value	Unit
$V_{CBO}$	Collector-Base Voltage	-160	V
$V_{CEO}$	Collector-Emitter Voltage	-150	V
$V_{EBO}$	Emitter-Base Voltage	-5	V
$I_C$	Collector Current	-0.6	A
$P_C$	Collector Power Dissipation	0.3	W
$R_{\theta JA}$	Thermal Resistance from Junction to Ambient	416	$^\circ\text{C}/\text{W}$
$T_j$	Junction Temperature	150	$^\circ\text{C}$
$T_{stg}$	Storage Temperature	-55~+150	$^\circ\text{C}$

### ELECTRICAL CHARACTERISTICS ( $T_a=25^\circ\text{C}$ unless otherwise specified)

Parameter	Symbol	Test conditions	Min	Typ	Max	Unit
Collector-base breakdown voltage	$V_{(BR)CBO}$	$I_C=-100\mu\text{A}, I_E=0$	-160			V
Collector-emitter breakdown voltage	$V_{(BR)CEO}^*$	$I_C=-1\text{mA}, I_B=0$	-150			V
Emitter-base breakdown voltage	$V_{(BR)EBO}$	$I_E=-10\mu\text{A}, I_C=0$	-5			V
Collector cut-off current	$I_{CBO}$	$V_{CB}=-120\text{V}, I_E=0$			-0.1	$\mu\text{A}$
Emitter cut-off current	$I_{EBO}$	$V_{EB}=-4\text{V}, I_C=0$			-0.1	$\mu\text{A}$
DC current gain	$h_{FE(1)}^*$	$V_{CE}=-5\text{V}, I_C=-1\text{mA}$	80			
	$h_{FE(2)}^*$	$V_{CE}=-5\text{V}, I_C=-10\text{mA}$	100		300	
	$h_{FE(3)}^*$	$V_{CE}=-5\text{V}, I_C=-50\text{mA}$	50			
Collector-emitter saturation voltage	$V_{CE(sat)1}^*$	$I_C=-10\text{mA}, I_B=-1\text{mA}$			-0.2	V
	$V_{CE(sat)2}^*$	$I_C=-50\text{mA}, I_B=-5\text{mA}$			-0.5	V
Base-emitter saturation voltage	$V_{BE(sat)1}^*$	$I_C=-10\text{mA}, I_B=-1\text{mA}$			-1	V
	$V_{BE(sat)2}^*$	$I_C=-50\text{mA}, I_B=-5\text{mA}$			-1	V
Transition frequency	$f_T$	$V_{CE}=-5\text{V}, I_C=-10\text{mA}, f=30\text{MHz}$	100			MHz

\*Pulse test: pulse width  $\leq 300\mu\text{s}$ , duty cycles  $\leq 2.0\%$ .

### CLASSIFICATION OF $h_{FE(2)}$

RANGE	100-300

## Typical Characteristics

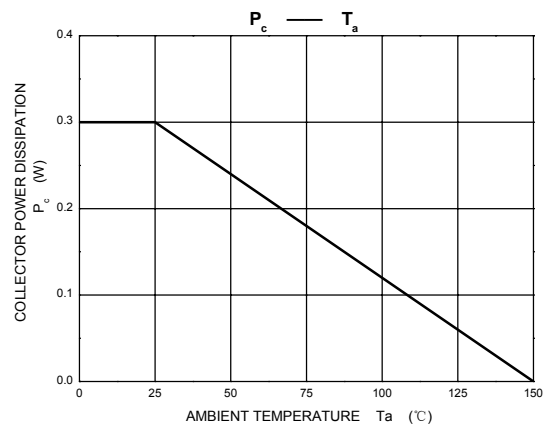
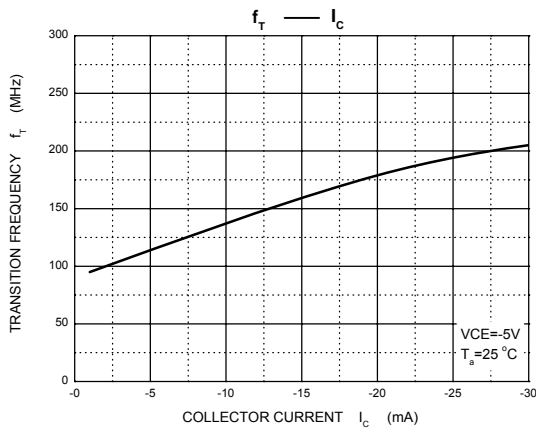
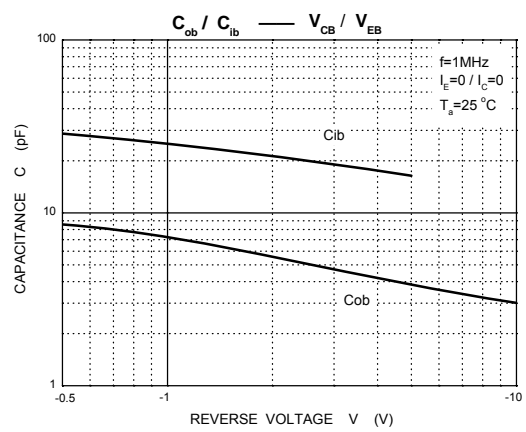
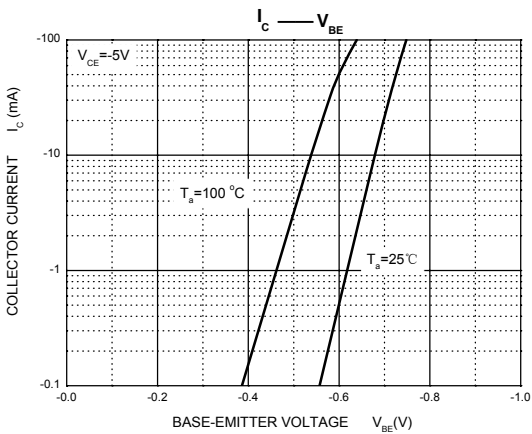
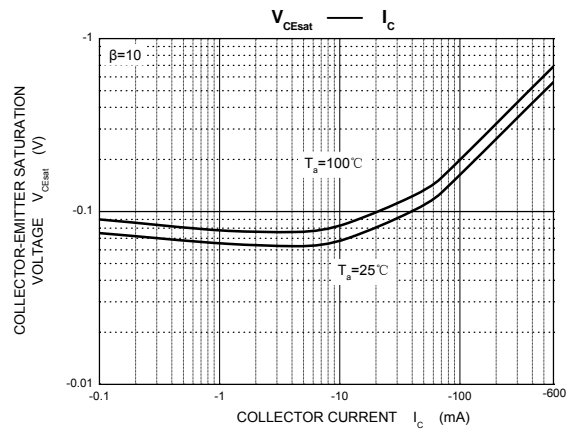
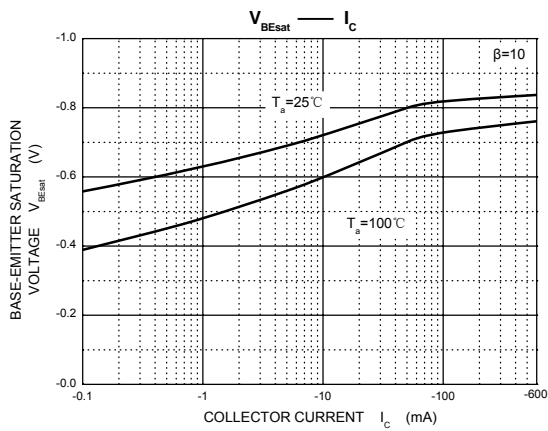
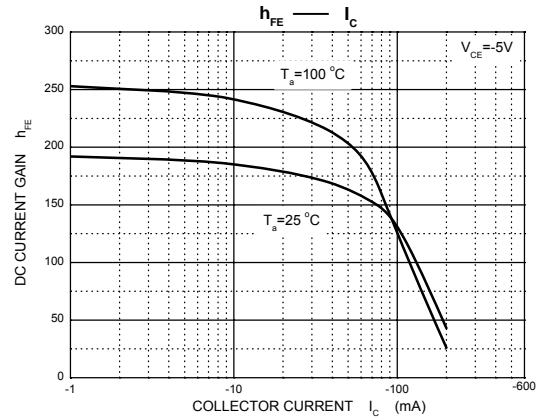
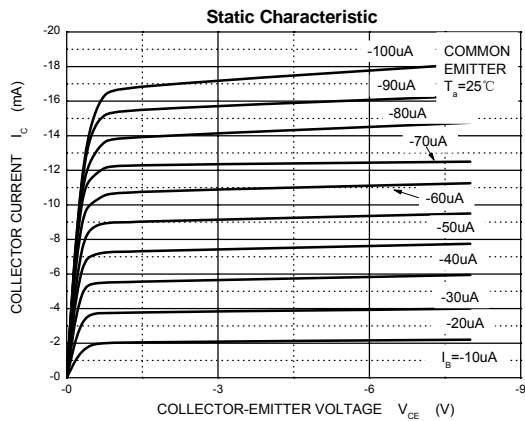

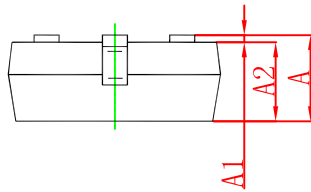
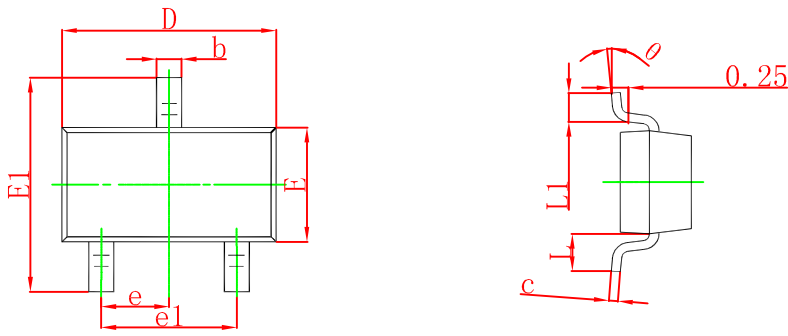

Symbol	Dimensions In Millimeters		Dimensions In Inches	
	Min	Max	Min	Max
A	0.900	1.150	0.035	0.045
A1	0.000	0.100	0.000	0.004
A2	0.900	1.050	0.035	0.041
b	0.300	0.500	0.012	0.020
c	0.080	0.150	0.003	0.006
D	2.800	3.000	0.110	0.118
E	1.200	1.400	0.047	0.055
E1	2.250	2.550	0.089	0.100
e	0.950 TYP		0.037 TYP	
e1	1.800	2.000	0.071	0.079
L	0.550 REF		0.022 REF	
L1	0.300	0.500	0.012	0.020
θ	0°	8°	0°	8°

### SOT-23 Suggested Pad Layout

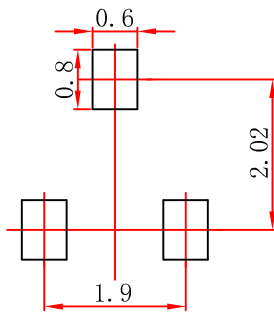

- Note:
1. Controlling dimension: in millimeters.
  2. General tolerance:  $\pm 0.05$  mm.
  3. The pad layout is for reference purposes only.