

SOT-23 Plastic-Encapsulate Transistors

FEATURES

- Epitaxial planar die construction
- Complementary PNP Type available( TKMMBT2907A)

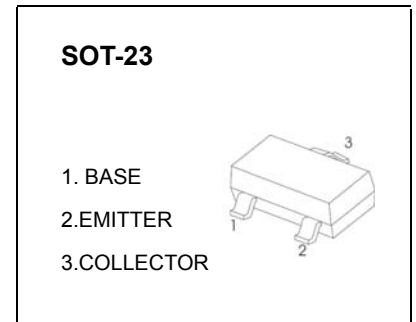

MAXIMUM RATINGS (Ta=25°C unless otherwise noted)

Symbol	Parameter	Value	Unit
V <sub>CB0</sub>	Collector-Base Voltage	75	V
V <sub>CEO</sub>	Collector-Emitter Voltage	40	V
V <sub>EBO</sub>	Emitter-Base Voltage	6	V
I <sub>C</sub>	Collector Current -Continuous	600	mA
P <sub>C</sub>	Collector Dissipation	300	mW
R <sub>θJA</sub>	Thermal Resistance, Junction to Ambient	417	°C/W
T <sub>J</sub>	Junction Temperature	150	°C
T <sub>stg</sub>	Storage Temperature	-55~+150	°C

ELECTRICAL CHARACTERISTICS (Ta=25°C unless otherwise specified)

Parameter	Symbol	Test conditions	Min	Typ	Max	Unit
Collector-base breakdown voltage	V <sub>(BR)CBO</sub>	I <sub>C</sub> = 10μA, I <sub>E</sub> =0	75			V
Collector-emitter breakdown voltage	V <sub>(BR)CEO</sub> *	I <sub>C</sub> = 10mA, I <sub>B</sub> =0	40			V
Emitter-base breakdown voltage	V <sub>(BR)EBO</sub>	I <sub>E</sub> =10μA, I <sub>C</sub> =0	6			V
Collector cut-off current	I <sub>CBO</sub>	V <sub>CB</sub> =60V, I <sub>E</sub> =0			0.01	μA
Collector cut-off current	I <sub>CEX</sub>	V <sub>CE</sub> =30V, V <sub>BE(off)</sub> =3V			0.01	μA
Emitter cut-off current	I <sub>EBO</sub>	V <sub>EB</sub> = 3V, I <sub>C</sub> =0			0.1	μA
DC current gain	h <sub>FE(1)</sub> *	V <sub>CE</sub> =10V, I <sub>C</sub> = 150mA	100		300	
	h <sub>FE(2)</sub>	V <sub>CE</sub> =10V, I <sub>C</sub> = 0.1mA	40			
	h <sub>FE(3)</sub> *	V <sub>CE</sub> =10V, I <sub>C</sub> = 500mA	42			
Collector-emitter saturation voltage	V <sub>CE(sat)</sub> *	I <sub>C</sub> =500 mA, I <sub>B</sub> = 50mA I <sub>C</sub> =150 mA, I <sub>B</sub> =15mA			1 0.3	V
Base-emitter saturation voltage	V <sub>BE(sat)</sub> *	I <sub>C</sub> =500 mA, I <sub>B</sub> = 50mA I <sub>C</sub> =150 mA, I <sub>B</sub> =15mA			2.0 1.2	V
Transition frequency	f <sub>T</sub>	V <sub>CE</sub> =20V, I <sub>C</sub> = 20mA, f=100MHz	300			MHz
Delay time	t <sub>d</sub>	V <sub>CC</sub> =30V, V <sub>BE(off)</sub> =-0.5V I <sub>C</sub> =150mA, I <sub>B1</sub> = 15mA			10	ns
Rise time	t <sub>r</sub>				25	ns
Storage time	t <sub>s</sub>	V <sub>CC</sub> =30V, I <sub>C</sub> =150mA			225	ns
Fall time	t <sub>f</sub>	I <sub>B1</sub> =-I <sub>B2</sub> =15mA			60	ns

\*pulse test: Pulse Width ≤300μs, Duty Cycle≤ 2.0%.

CLASSIFICATION OF h<sub>FE(1)</sub>

RANGE	100 - 300
MARKING	1D

## Typical Characteristics

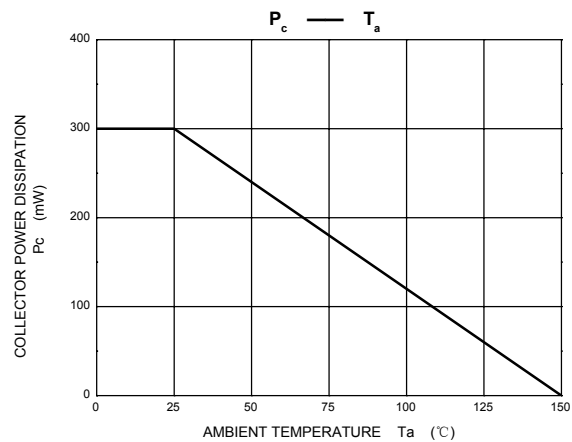
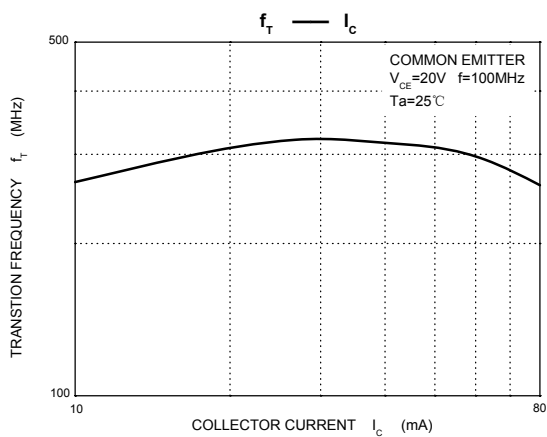
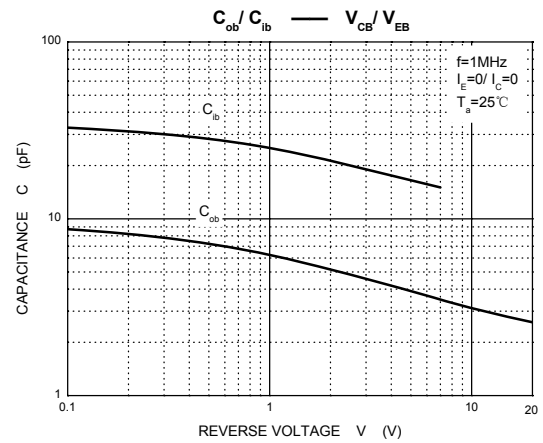
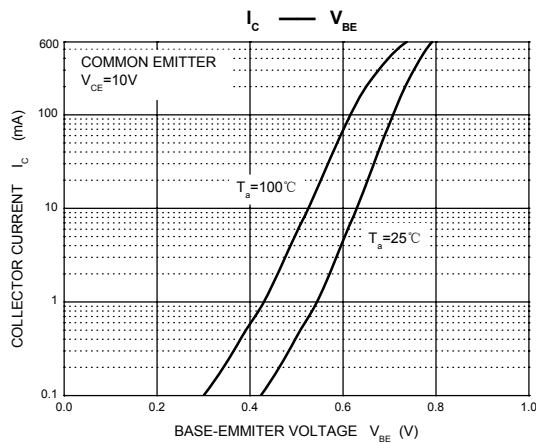
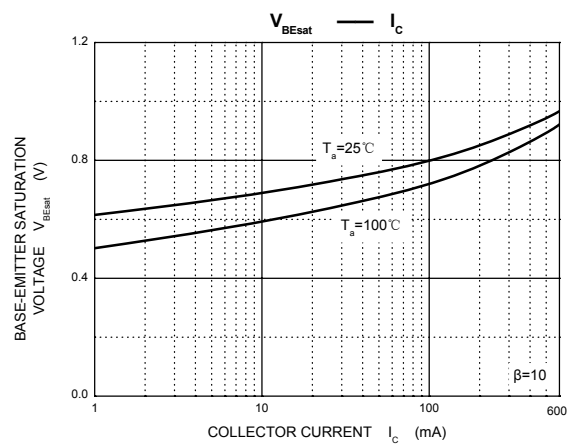
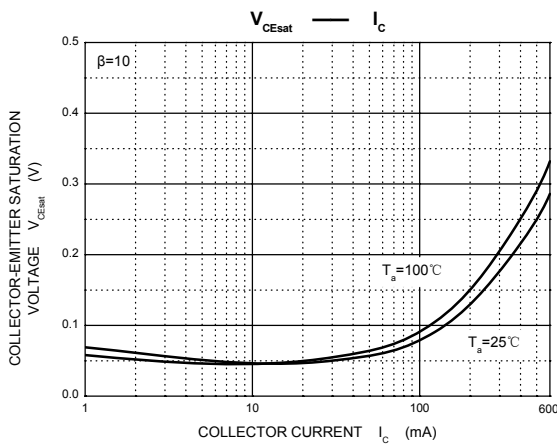
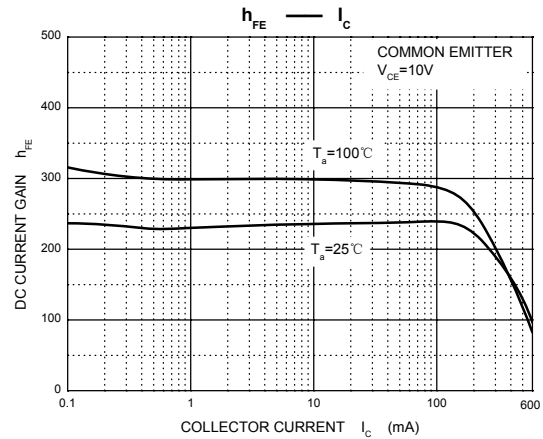
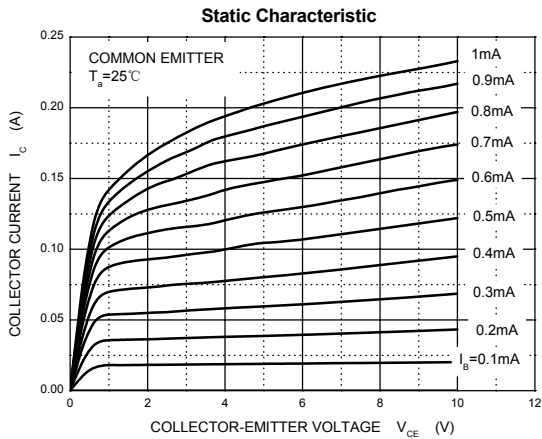

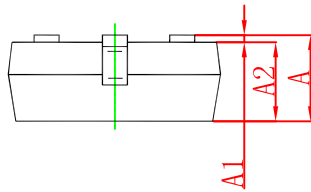
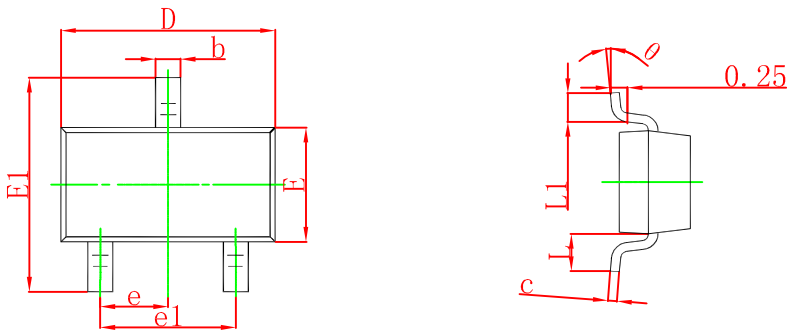

Symbol	Dimensions In Millimeters		Dimensions In Inches	
	Min	Max	Min	Max
A	0.900	1.150	0.035	0.045
A1	0.000	0.100	0.000	0.004
A2	0.900	1.050	0.035	0.041
b	0.300	0.500	0.012	0.020
c	0.080	0.150	0.003	0.006
D	2.800	3.000	0.110	0.118
E	1.200	1.400	0.047	0.055
E1	2.250	2.550	0.089	0.100
e	0.950 TYP		0.037 TYP	
e1	1.800	2.000	0.071	0.079
L	0.550 REF		0.022 REF	
L1	0.300	0.500	0.012	0.020
θ	0°	8°	0°	8°

### SOT-23 Suggested Pad Layout

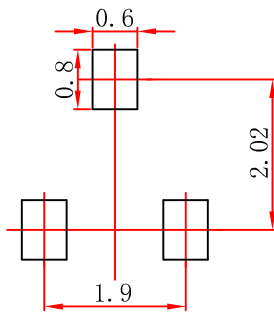

- Note:
1. Controlling dimension: in millimeters.
  2. General tolerance:  $\pm 0.05\text{mm}$ .
  3. The pad layout is for reference purposes only.