

FEATURES

- Guard ring protection
- Low forward voltage drop
- For use in low voltage, high frequency inverters
- High surge current capability

SOD-323 Plastic-Encapsulate Diodes

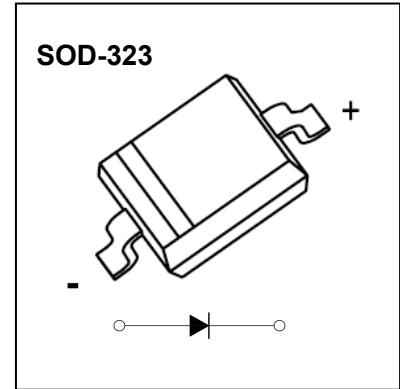

Marking: SH



MAXIMUM RATINGS(Ta=25°C unless otherwise noted)

Symbol	Parameter	Value	Unit
V_{RRM}	Maximum recurrent peak reverse voltage	60	V
V_{RMS}	Maximum RMS voltage	42	
V_{DC}	Maximum DC blocking voltage	60	
I_F	Continuous forward current	1	A
I_{FSM}	Non-repetitive Peak forward surge current@t=8.3ms	10	
P_{tot}	Total power dissipation	250	mW
$R_{\theta JA}$	Thermal resistance junction to ambient air	400	°C/W
T_J	Junction temperature	125	°C
T_{stg}	storage temperature	-55~+150	°C

ELECTRICAL CHARACTERISTICS(Ta=25°C unless otherwise specified)

Parameter	Symbol	Test conditions	Min	Typ	Max	Unit
Maximum instantaneous forward voltage	V_F	$I_F=1A$			0.7	V
Maximum DC reverse current at rated DC blocking voltage	I_R	$V_R=60V$			0.1	mA
Total capacitance	C_{tot}	$V_R=4V, f=1MHz$			120	pF

Typical Characteristics

Forward Characteristics

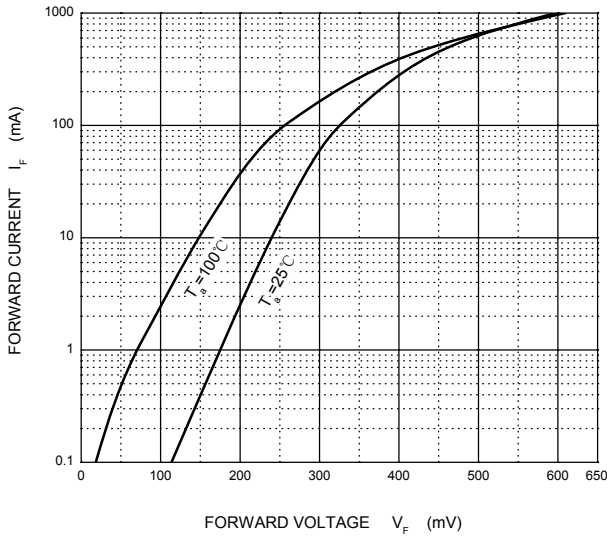

Reverse Characteristics

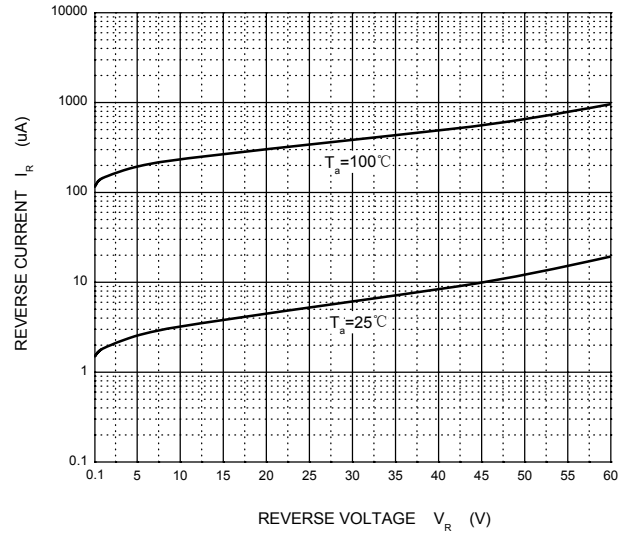

Capacitance Characteristics

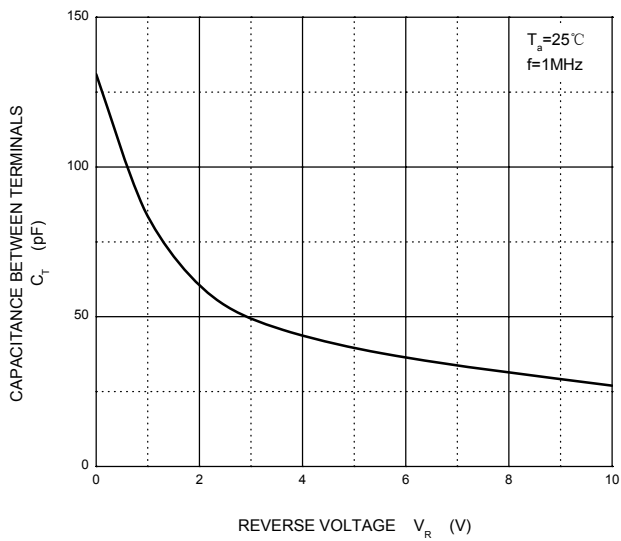

Power Derating Curve

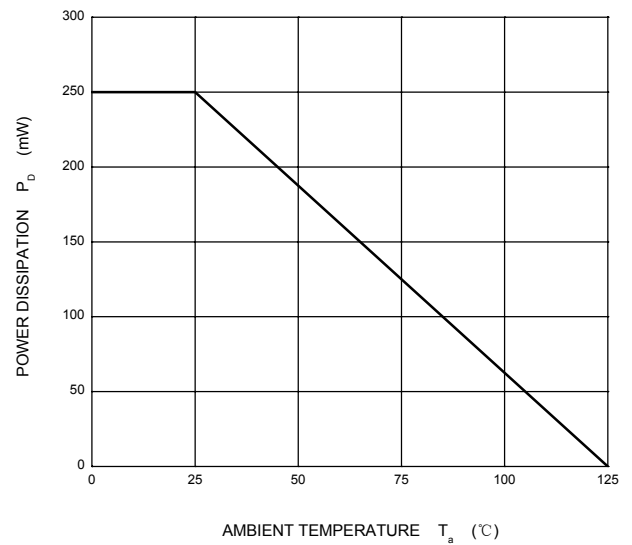

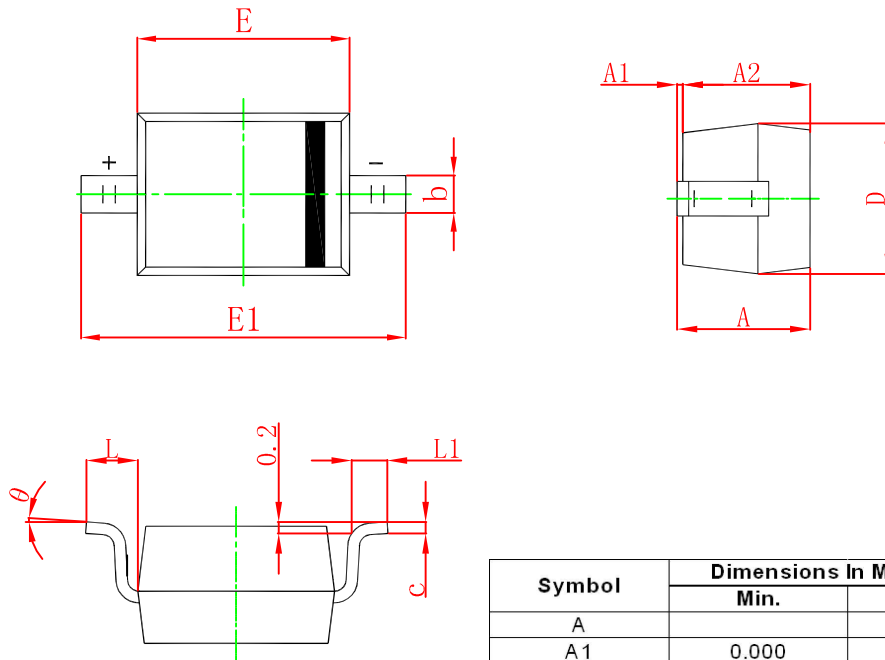

Symbol	Dimensions In Millimeters		Dimensions In Inches	
	Min.	Max.	Min.	Max.
A		1.000		0.039
A1	0.000	0.100	0.000	0.004
A2	0.800	0.900	0.031	0.035
b	0.250	0.350	0.010	0.014
c	0.080	0.150	0.003	0.006
D	1.200	1.400	0.047	0.055
E	1.600	1.800	0.063	0.071
E1	2.550	2.750	0.100	0.108
L	0.475 REF.		0.019 REF.	
L1	0.250	0.400	0.010	0.016
θ	0°	8°	0°	8°

SOD-323 Suggested Pad Layout

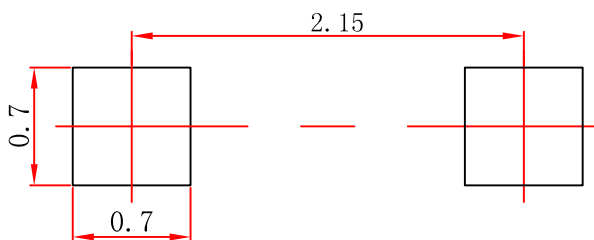

Note:

1. Controlling dimension: in millimeters.
2. General tolerance: ± 0.05 mm.
3. The pad layout is for reference purposes only.