

SOT-23 Plastic-Encapsulate Transistors

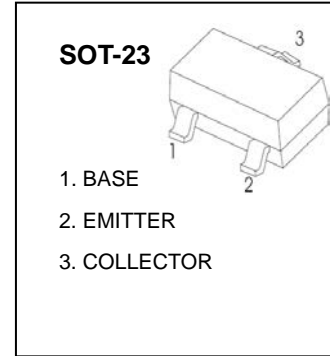

FEATURES

- Low C_{ob} , $C_{ob} = 2.0 \text{ pF (Typ)}$.

MARKING : BQ, BR, BS

MAXIMUM RATINGS ($T_a=25^\circ\text{C}$ unless otherwise noted)

Symbol	Parameter	Value	Unit
V_{CBO}	Collector-Base Voltage	60	V
V_{CEO}	Collector-Emitter Voltage	50	V
V_{EBO}	Emitter-Base Voltage	7	V
I_C	Collector Current	150	mA
P_C	Collector Power Dissipation	200	mW
$R_{\theta JA}$	Thermal Resistance From Junction To Ambient	625	$^\circ\text{C/W}$
T_J, T_{stg}	Operation Junction and Storage Temperature Range	-55~+150	$^\circ\text{C}$

ELECTRICAL CHARACTERISTICS ($T_a=25^\circ\text{C}$ unless otherwise specified)

Parameter	Symbol	Test conditions	Min	Typ	Max	Unit
Collector-base breakdown voltage	$V_{(BR)CBO}$	$I_C=50\mu\text{A}, I_E=0$	60			V
Collector-emitter breakdown voltage	$V_{(BR)CEO}$	$I_C=1\text{mA}, I_B=0$	50			V
Emitter-base breakdown voltage	$V_{(BR)EBO}$	$I_E=50\mu\text{A}, I_C=0$	7			V
Collector cut-off current	I_{CBO}	$V_{CB}=60\text{V}, I_E=0$			0.1	μA
Emitter cut-off current	I_{EBO}	$V_{EB}=7\text{V}, I_C=0$			0.1	μA
DC current gain	h_{FE}	$V_{CE}=6\text{V}, I_C=1\text{mA}$	120		560	
Collector-emitter saturation voltage	$V_{CE(sat)}$	$I_C=50\text{mA}, I_B=5\text{mA}$			0.4	V
Transition frequency	f_T	$V_{CE}=12\text{V}, I_C=-2\text{mA}, f=100\text{MHz}$		160		MHz
Collector output capacitance	C_{ob}	$V_{CB}=12\text{V}, I_E=0, f=1\text{MHz}$		2.0	3.5	pF

CLASSIFICATION OF h_{FE}

Rank	Q	R	S
Range	120 - 270	180 - 390	270 - 560
Marking	BQ	BR	BS

Typical Characteristics

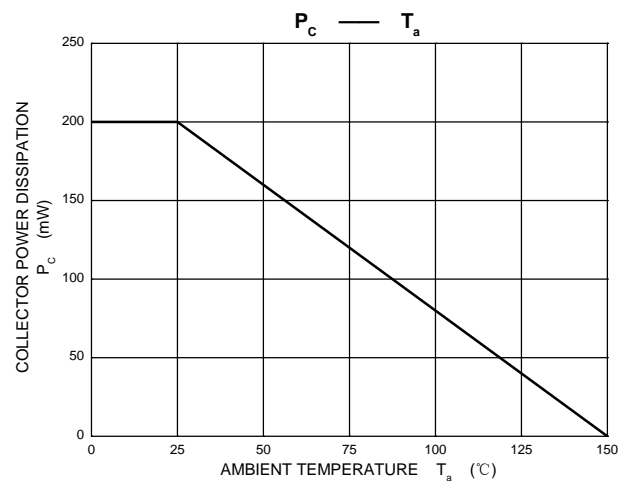
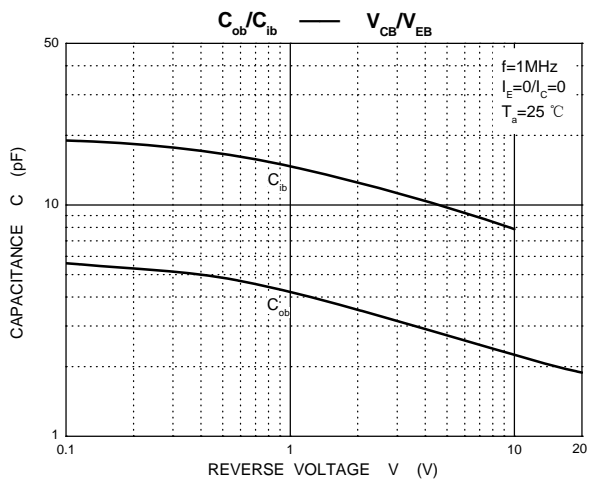
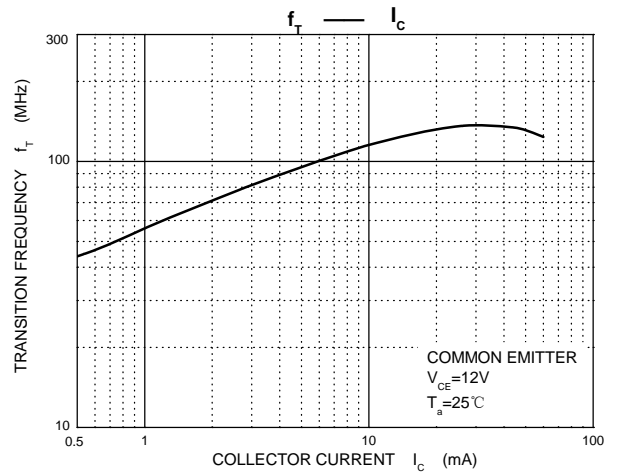
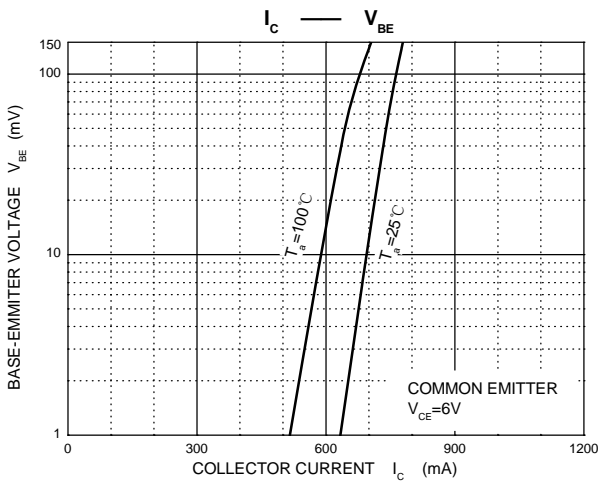
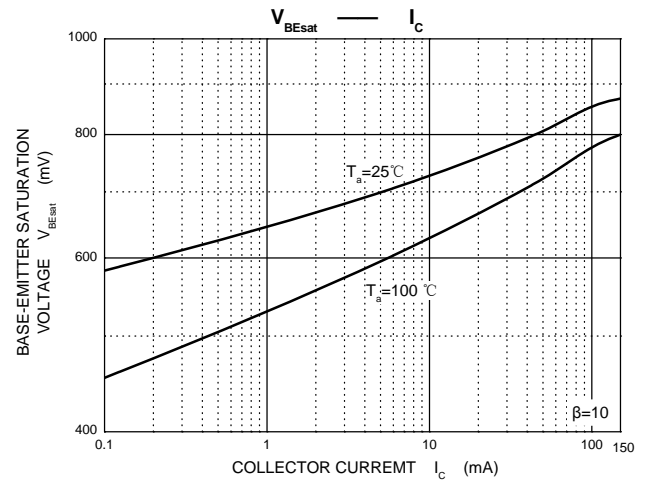
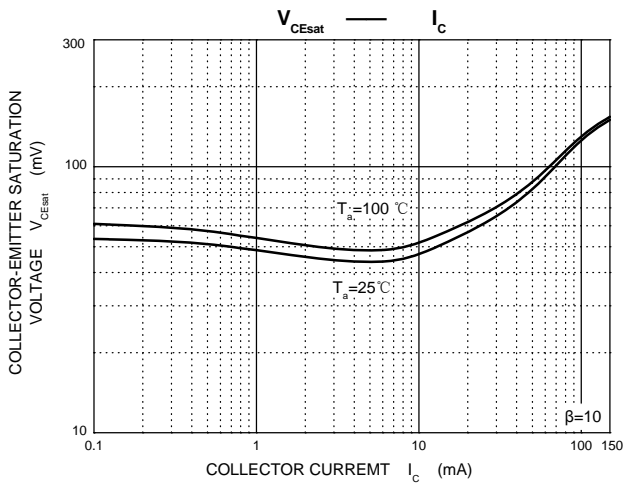
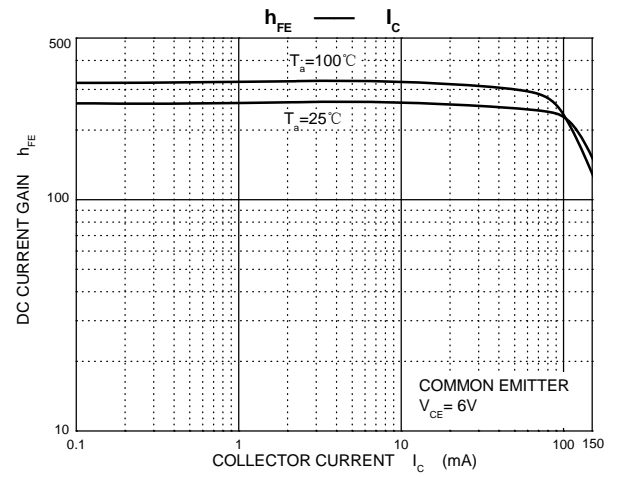
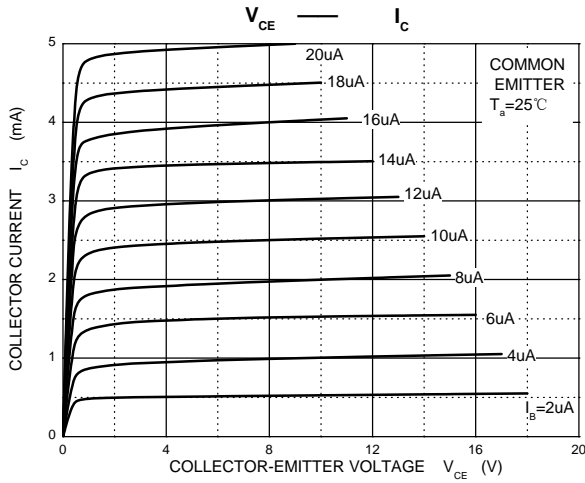

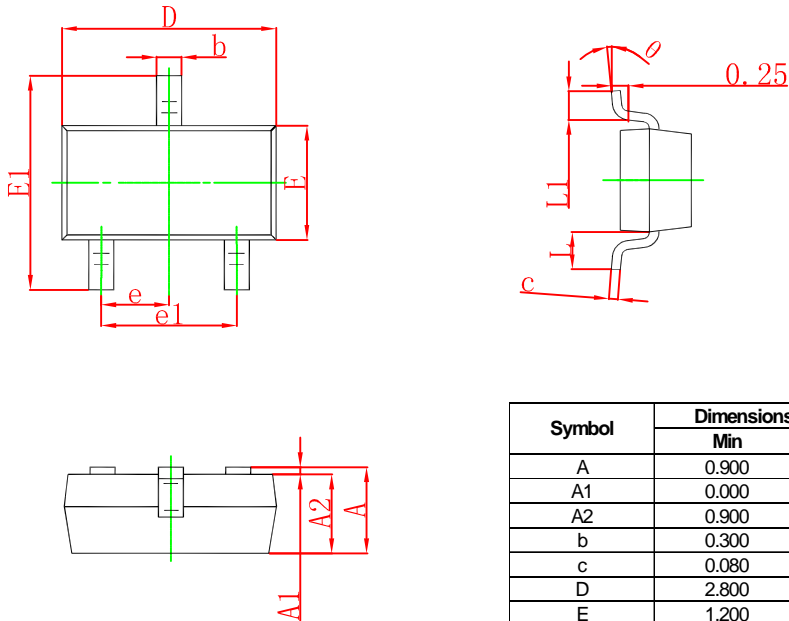

Symbol	Dimensions In Millimeters		Dimensions In Inches	
	Min	Max	Min	Max
A	0.900	1.150	0.035	0.045
A1	0.000	0.100	0.000	0.004
A2	0.900	1.050	0.035	0.041
b	0.300	0.500	0.012	0.020
c	0.080	0.150	0.003	0.006
D	2.800	3.000	0.110	0.118
E	1.200	1.400	0.047	0.055
E1	2.250	2.550	0.089	0.100
e	0.950 TYP		0.037 TYP	
e1	1.800	2.000	0.071	0.079
L	0.550 REF		0.022 REF	
L1	0.300	0.500	0.012	0.020
θ	0°	8°	0°	8°

SOT-23 Suggested Pad Layout

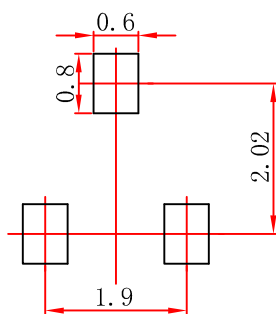

- Note:
1. Controlling dimension: in millimeters.
 2. General tolerance: ± 0.05 mm.
 3. The pad layout is for reference purposes only.