

SOD-523 Plastic-Encapsulate Diodes

FEATURES

- Small surface mounting type
- High speed
- High reliability with high surge current handing capability

MARKING:A

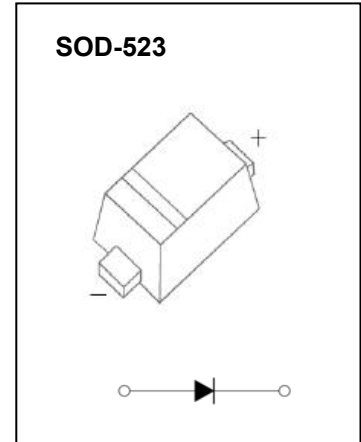

Maximum Ratings and Electrical Characteristics, Single Diode @Ta=25°C

Parameter	Symbol	Limit	Unit
Non-Repetitive Peak Reverse Voltage	V_{RM}	90	V
DC Blocking Voltage	V_R	80	V
Forward Continuous Current	I_{FM}	225	mA
Average Rectified Output Current	I_O	100	mA
Non-Repetitive Peak Forward Surge Current @ t=8.3ms	I_{FSM}	2.0	A
Power Dissipation	P_d	150	mW
Thermal Resistance Junction to Ambient	$R_{\theta JA}$	833	°C/W
Operation Junction and Storage Temperature Range	T_J, T_{STG}	-55~+150	°C

Electrical Ratings @Ta=25°C

Parameter	Symbol	Min.	Typ.	Max.	Unit	Conditions
Forward voltage	V_F			1.2	V	$I_F=100mA$
Reverse current	I_R			0.1	μA	$V_R=80V$
Capacitance between terminals	C_T			3.0	pF	$V_R=0.5V, f=1MHz$
Reverse recovery time	t_{rr}			4	ns	$V_R=6V, I_F=10mA, R_L=100\Omega$

Typical Characteristics

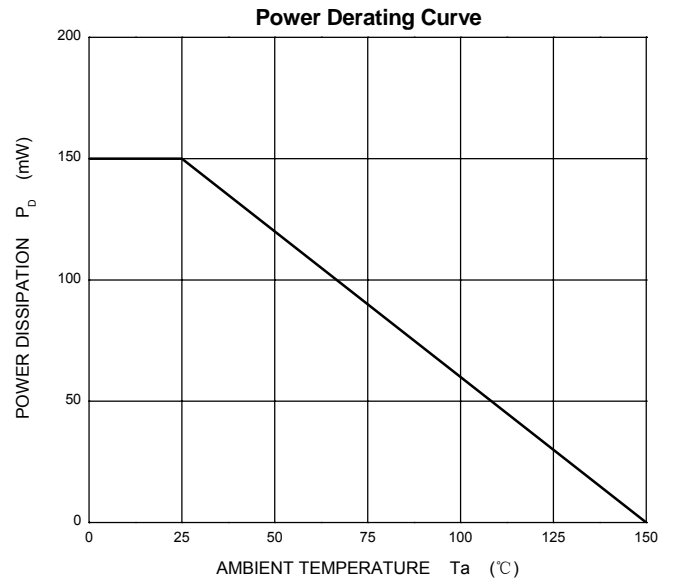
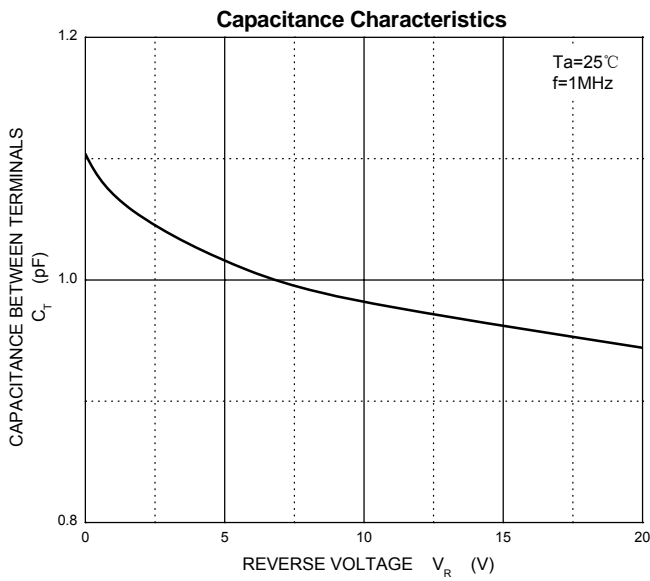
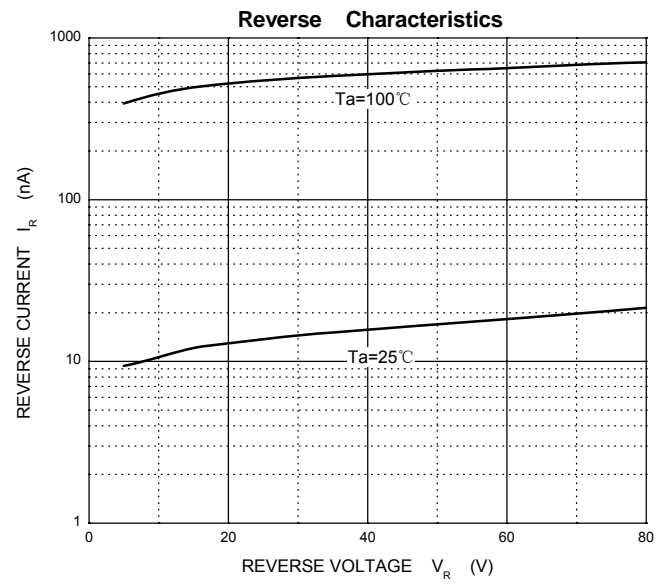
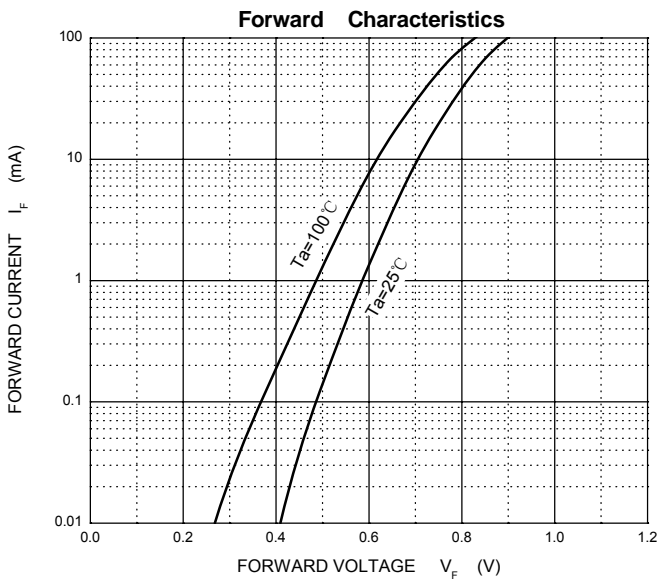

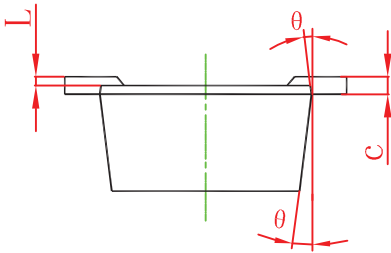
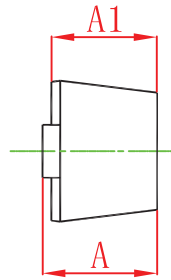
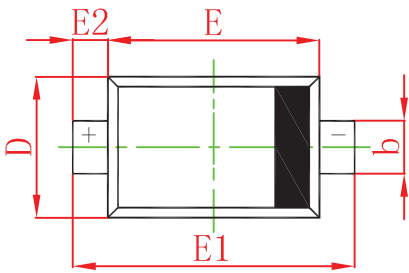

Symbol	Dimensions In Millimeters		Dimensions In Inches	
	Min	Max	Min	Max
A	0.510	0.770	0.020	0.031
A1	0.500	0.700	0.020	0.028
b	0.250	0.350	0.010	0.014
c	0.080	0.150	0.003	0.006
D	0.750	0.850	0.030	0.033
E	1.100	1.300	0.043	0.051
E1	1.500	1.700	0.059	0.067
E2	0.200 REF		0.008 REF	
L	0.010	0.070	0.001	0.003
θ	7° REF		7° REF	

SOD-523 Suggested Pad Layout

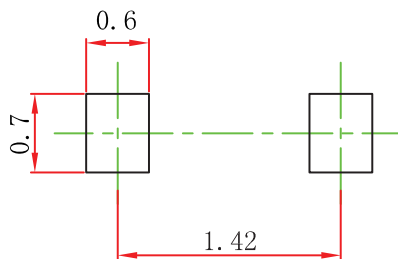

Note:

1. Controlling dimension: in millimeters.
2. General tolerance: $\pm 0.05\text{mm}$.
3. The pad layout is for reference purposes only.