

GLASS PASSIVATED BRIDGE RECTIFIERS

REVERSE VOLTAGE - **50 to 1000** Volts
FORWARD CURRENT - **3.0** Amperes

FEATURES

- Rating to 1000V PRV
- Ideal for printed circuit board
- Reliable low cost construction utilizing molded plastic technique
- The plastic material has UL flammability classification 94V#0

MECHANICAL DATA

- Polarity : As marked on body
- Weight : 0.05 ounces, 1.52 grams
- Mounting position : Any

KBP

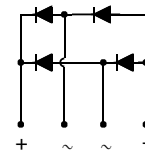
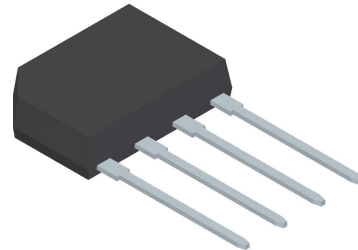

MAXIMUM RATINGS AND ELECTRICAL CHARACTERISTICS

Ratings at 25°C ambient temperature unless otherwise specified.

CHARACTERISTICS	SYMBOL	KBP 3005	KBP 301	KBP 302	KBP 304	KBP 306	KBP 308	KBP 310	UNIT
Maximum Repetitive Peak Reverse Voltage	V_{RRM}	50	100	200	400	600	800	1000	V
Maximum RMS Voltage	V_{RMS}	35	70	140	280	420	560	700	V
Maximum DC Blocking Voltage	V_{DC}	50	100	200	400	600	800	1000	V
Maximum Average Forward Rectified Current @ $T_C=105^\circ C$	$I_{(AV)}$	3.0							A
Peak Forward Surge Current 8.3ms single half sine-wave @ $T_j = 25^\circ C$	I_{FSM}	60							A
Maximum Forward Voltage at 3.0A DC	V_F	1.1							V
Maximum DC Reverse Current at rated Blocking Voltage @ $T_j=25^\circ C$ @ $T_j=125^\circ C$	I_R	5.0 500							μA
I^2t Rating for fusing ($3ms \leq t \leq 8.3ms$)	I^2t	14.94							A^2S
Typical Junction Capacitance per element (Note 1)	C_J	60							pF
Typical thermal resistance (Unit mounted on 30mmx30mmx1mm Copper plate heatsink.)	$R_{\theta JC}$ $R_{\theta JL}$ $R_{\theta JA}$	10 12 30							$^\circ C/W$
Typical thermal resistance (without heatsink)	$R_{\theta JC}$ $R_{\theta JL}$ $R_{\theta JA}$	12 18 40							$^\circ C/W$
Operation Temperature Range	T_J	-55 to +150							$^\circ C$
Storage Temperature Range	T_{STG}	-55 to +150							$^\circ C$

Note: (1) Measured at 1.0MHz and applied reverse voltage of 4.0V DC.

FIG.1- FORWARD CURRENT DERATING CURVE

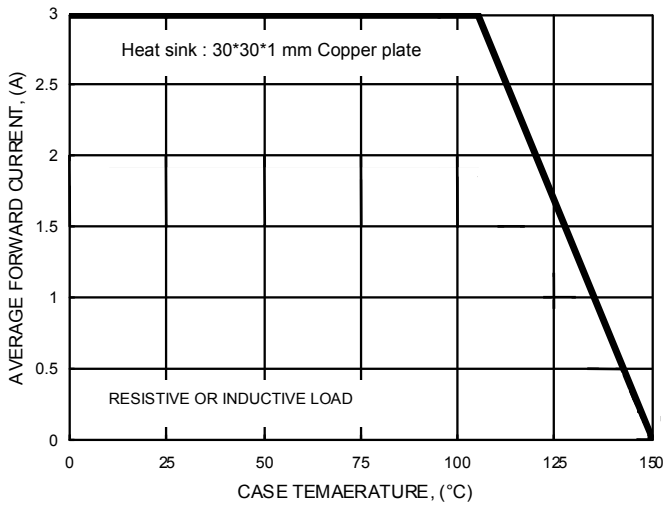

FIG.2- MAXIMUM NON-REPETITIVE SURGE CURRENT

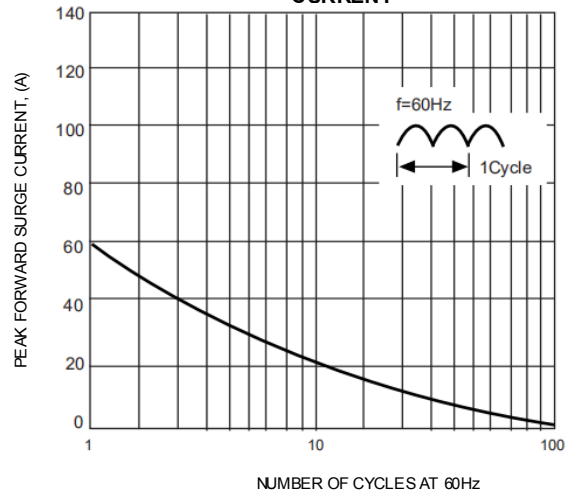

FIG.3- TYPICAL JUNCTION CAPACITANCE

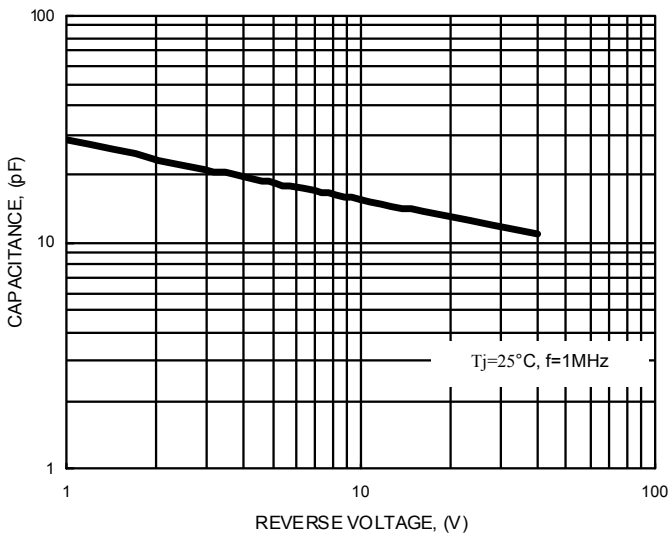

FIG.4- TYPICAL FORWARD CHARACTERISTICS

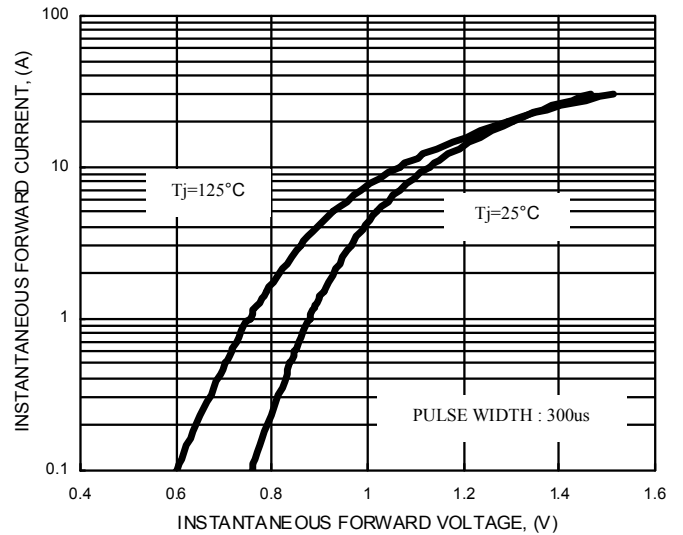
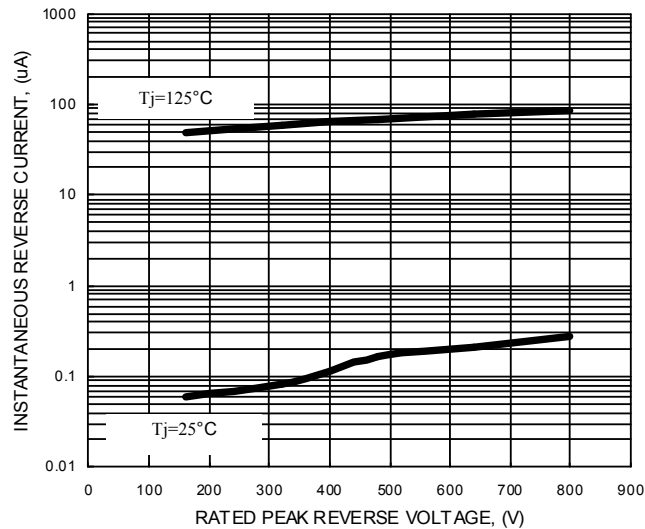
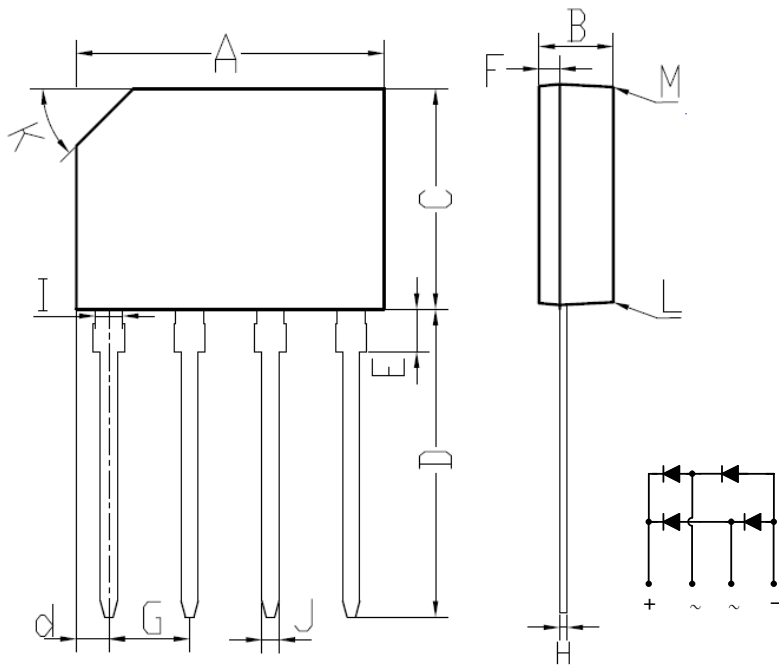

FIG.5- TYPICAL REVERSE CHARACTERISTICS





KBP		
DIM.	MIN.	MAX.
A	14.20	14.70
B	3.30	3.60
C	10.20	10.60
D	13.80	14.40
d	1.40	1.70
E	1.80	2.20
F	0.80	1.10
G	3.71	3.91
H	0.35	0.55
I	1.22	1.42
J	0.76	0.86
K	2.7 x 45° (Typ)	
L	#	3°
M	#	2°
All Dimensions in millimeter		